

**Tower Crane
Grue à tour**

Turmdrehkran 63 K



DIN

Maßstab: 1:280
scale / échelle

LIEBHERR

36,6 m (3 Turmstücke) Tower section
39,0 m (4 Turmstücke) Élément de mât

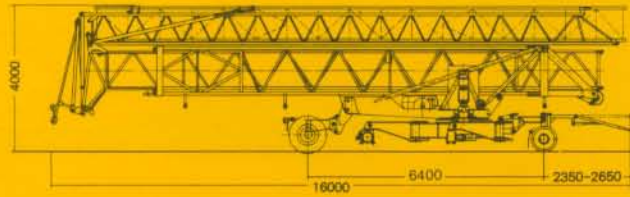
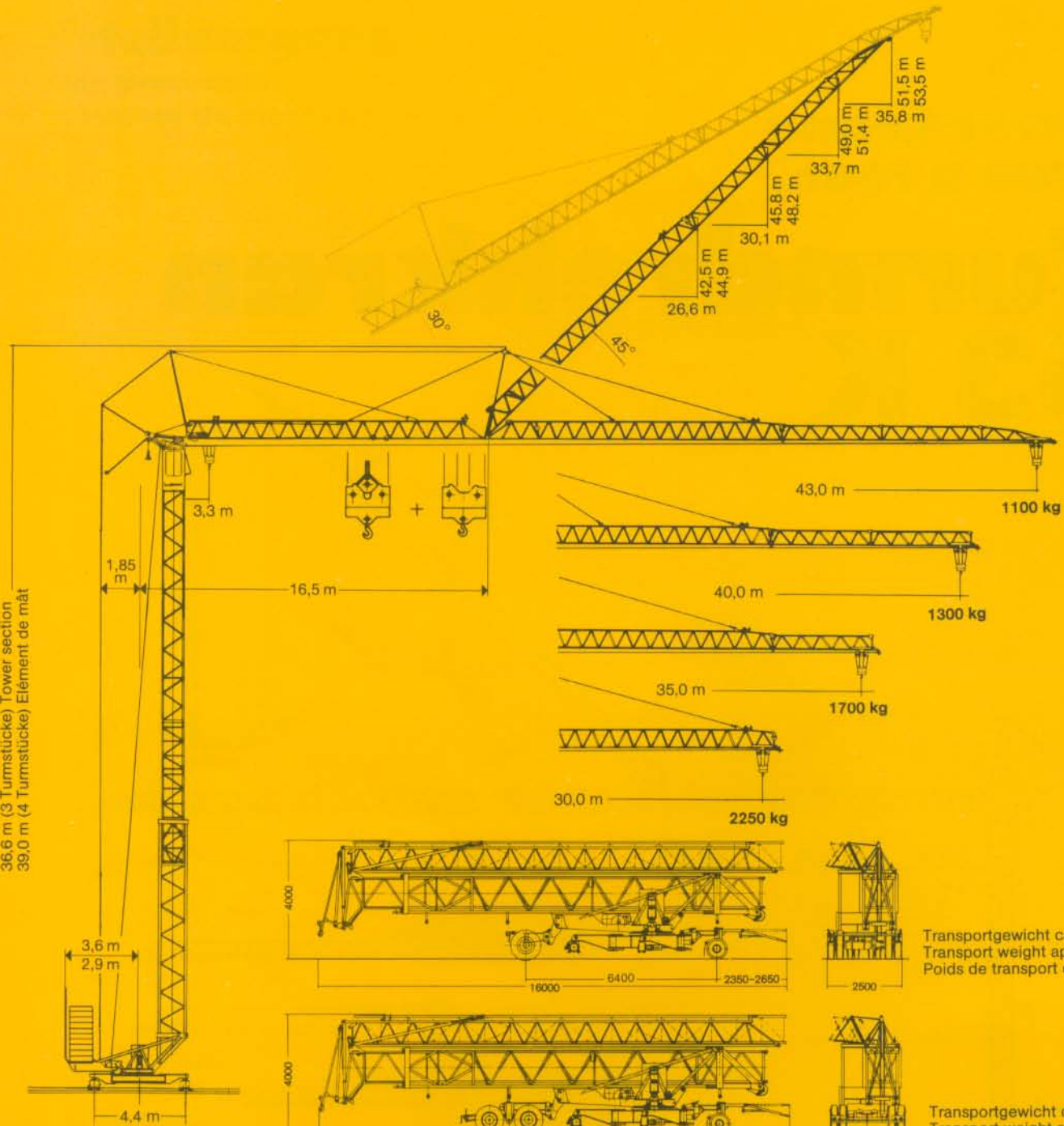

Transportgewicht ca. 18140 kg
Transport weight approx.
Poids de transport env.

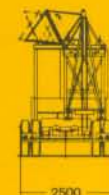
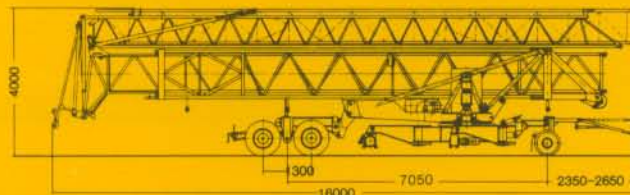

Transportgewicht ca. 19800 kg
Transport weight approx.
Poids de transport env.

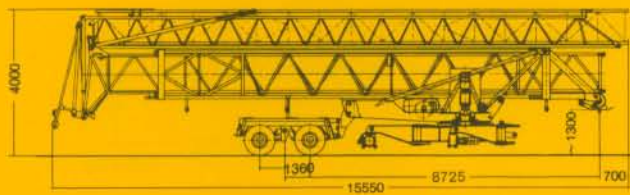

Transportgewicht ca. 19440 kg
Transport weight approx.
Poids de transport env.

Gewicht Weight Poids

Max. Eckkraft in Betrieb Max. corner pressure in operation Réaction maxi. par angle en service	298 kN*
Max. Eckkraft außer Betrieb Max. corner pressure out of operation Réaction maxi. par angle hors service	200 kN*

Gegengewicht ca. Counter weight approx. Contrepoids env.	r = 3,6 m r = 2,9 m	26000 kg 34000 kg
Konstruktionsgewicht (max. Ausladung + Hakenhöhe) ca. Dead weight (max. radius + hook height) approx. Poids de la construction (max. portée + hauteur sous crochet) env.		18800 kg

* Umrechnung der Einheiten für Kräfte 1 kp ≈ 10 N; 10 kN ≈ 1 Mp./Conversion of the units for forces./Conversion des unités des forces.

63 K

Ausladung und Tragfähigkeit





Radius and capacity / Portée et charge

Auslegerlänge Length of jib Longueur de flèche m	max. kg m/kg		m/kg																				
			19,0	20,0	22,0	24,0	26,0	28,0	29,0	30,0	31,0	32,0	33,0	34,0	35,0	36,0	37,0	38,0	39,0	40,0	41,0	42,0	43,0
43,0	3,3-19,5 3050		3050	2970	2640	2380	2160	1970	1890	1800	1740	1670	1610	1550	1490	1440	1390	1350	1300	1260	1220	1180	1150
40,0	3,3-20,6 3050		3050	3050	2810	2530	2300	2100	2010	1900	1850	1780	1720	1650	1590	1540	1490	1440	1390	1350			
35,0	3,3-21,7 3050		3050	3050	3050	2760	2510	2290	2200	2110	2030	1950	1880	1810	1750								
30,0	3,3-25,3 3050		3050	3050	3050	3050	2960	2710	2600	2500													

m	max. kg m/kg		m/kg																				
			11,0	12,0	14,0	16,0	18,0	20,0	22,0	24,0	26,0	28,0	30,0	32,0	34,0	35,0	37,0	38,0	39,0	40,0	41,0	42,0	43,0
43,0	3,3-19,5 3000	-11,6 6000	6000	5730	4700	3960	3410	3000	2650	2370	2140	1950	1750	1640	1510	1460	1350	1300	1260	1220	1170	1140	1100
40,0	3,3-20,6 3000	-12,1 6000	6000	6000	4970	4190	3620	3170	2810	2520	2280	2070	1900	1750	1610	1550	1440	1390	1340	1300			
35,0	3,3-21,7 3000	-12,7 6000	6000	6000	5370	4540	3920	3440	3050	2740	2480	2260	2070	1910	1760	1700							
30,0	3,3-23,3- 3000	-13,8 6000	6000	6000	5800	4900	4240	3720	3310	2950	2690	2350	2250										

m	max. kg m/kg		Auslegersteilstellung 30° Elevated jib 30° Flèche inclinée 30° m/kg																				
			17,0	18,0	19,0	20,0	21,0	22,0	23,0	24,0	25,0	26,3	27,0	28,0	29,0	30,6	32,0	33,0	34,0	34,9	36,0	37,0	37,5
43,0	3,1-17,2 3050		3050	2890	2700	2540	2390	2260	2130	2020	1920	1800	1750	1670	1600	1490	1410	1360	1310	1260	1210	1170	1150
40,0	3,1-18,1 3050		3050	3050	2880	2700	2540	2400	2270	2160	2050	1900	1860	1780	1710	1590	1510	1450	1400	1350			
35,0	3,1-19,4 3050		3050	3050	3050	2950	2780	2620	2480	2360	2240	2110	2040	1950	1870	1750							
30,0	3,1-22,3 3050		3050	3050	3050	3050	3050	3050	2940	2790	2660	2500											

Geschwindigkeiten Speeds / Vitesses

	U/min 0 - 0,8 sl./min tr./min	3,0 kW
	20,0 / 40,0 m/min	1,5 / 2,2 kW
	25,0 m/min	2 x 1,5 kW
	0-45° ca. 60 sec.	4,0 kW

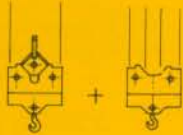
Hubwerk Hoist unit Mécanisme de levage	Stufe Step Cran	kg	m/min
15,6 kW 	1	3050	6,5
	2	3050	28,0
	3	1600	53,0
	1	3000 6000	6,5 3,25
	2	3000 6000	28,0 14,0
	3	1600 3200	53,0 26,5

Leitungsquerschnitt bei 380 V
Cross section of cable
Section de câble à

Betriebsspannung 380 V
Operating voltage
Tension de service

Technische Kenngröße nach BGL

Technical nominal size according to the construction machinery list (BGL)
Grandeur caractéristique suivant le barème d'emploi des appareils (BGL)

bis 99,0 m
up to
jusqu'à

Frequenz 50 Hz
Frequency
Fréquence

Anschlußwert 28,0 kVA
Power requirement
Puissance requise



2108-0063

Technische Daten - Technical data Caractéristiques techniques

Aufstellvorgang

Erection procedure

Déroulement de montage

Ballasterausladung 5,0 m

Ballasting radius 5,0 m

Portée pour dispositif de lestage 5,0 m

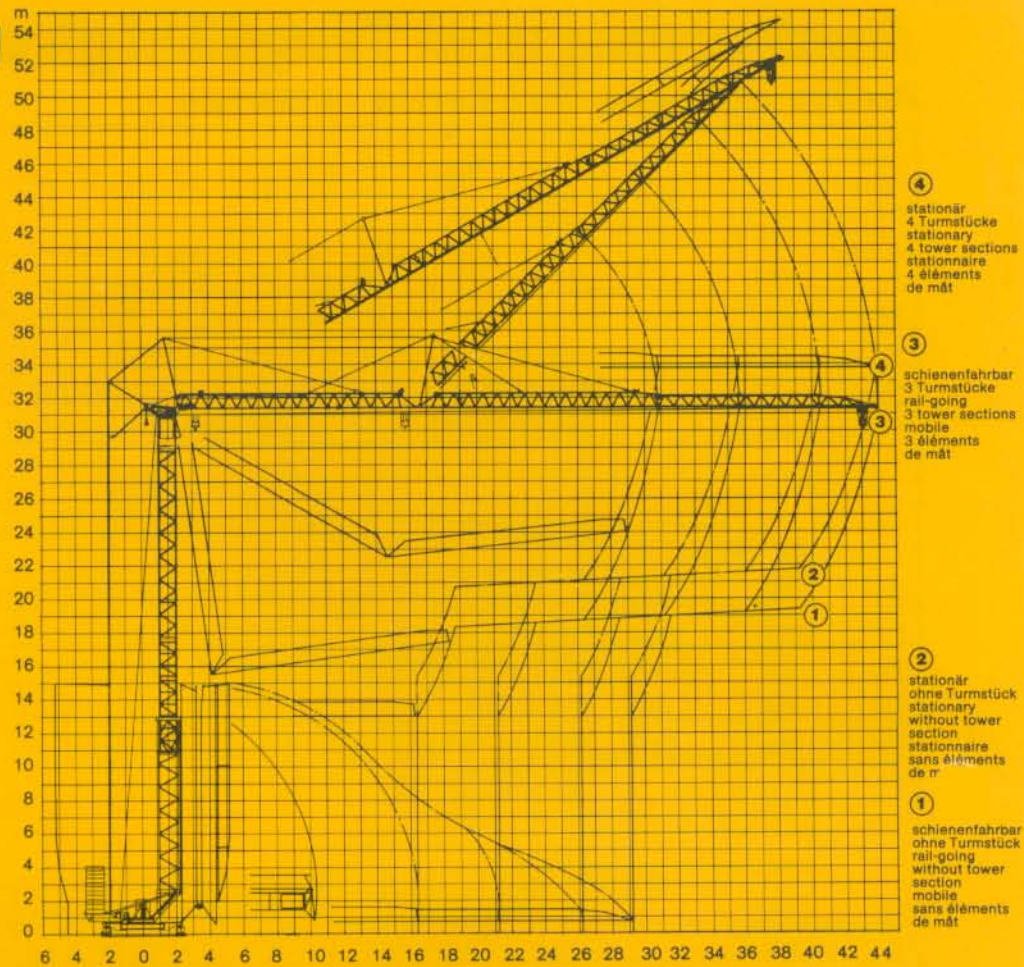

Kolli-Liste

Packing List

Liste de colisage

Pos. Item Rep.	Anz. Qty. Qté		L (m)	B (m)	H (m)	kg	
1	3	Turmstück (ohne Turmauflage) Tower section without tower support Élément de mât sans support de mât		2,50	1,10	1,10	450
2	1	Turmstück (mit Turmauflage) Tower section with tower support Élément de mât avec support de mât		2,50	1,10	1,10	550
3	1	Ausleger-Verlängerung 30,0 m – 35,0 m Jib extension Rallonge de la flèche		5,00	1,02	0,80	240
4	1	Ausleger-Verlängerung 35,0 m – 40,0 m Jib extension Rallonge de la flèche		5,10	1,02	0,70	180
5	1	Ausleger-Verlängerung 40,0 m – 43,0 m Jib extension Rallonge de la flèche		3,10	1,02	0,70	95
6	1	Transportachse vorne Tra 100 KY 1 Road transport axle front Essieux de transport avant		3,00	1,13	0,97	680
7	1	Transportachse hinten Tra 120 GY 1 Road transport axle behind Essieux de transport arrière		1,90	2,50	1,05	1200
8	1	Transportachse Tra 200 GZ 3 Road transport axle Essieux de transport		3,10	2,50	1,10	2500
9	1	Kiste mit Seilen und Kleinteilen Case with ropes and small parts Caisse avec câbles et pièces détachées		1,00	0,80	1,00	450

Datenblatt Nr. 120 P – 2501 H 1 B 3 DIN 15018 und OENORM T 3 • 04.94
Data sheet / Feuille de caractéristiques

Konstruktionsänderungen vorbehalten!
Subject to alterations! / Sous réserves de modifications!

Printed in Germany

Nehmen Sie Kontakt auf mit
Contact

Mettez-vous en rapport avec

LIEBHERR-WERK BIBERACH GMBH, Postfach 1663, D-88396 Biberach an der Riß

☎ (07351) 41-0, Fax (07351) 4 1225, Tx 71 802